

Contour

Deck Over

2" X 3-1/2"

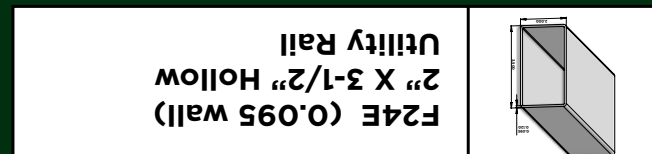
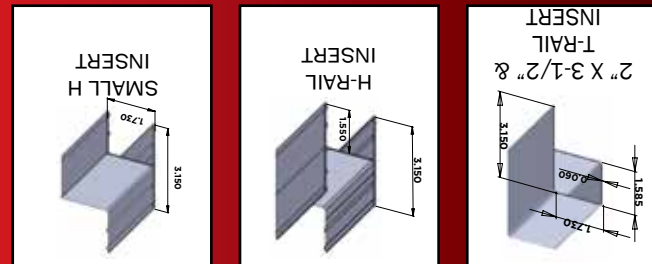
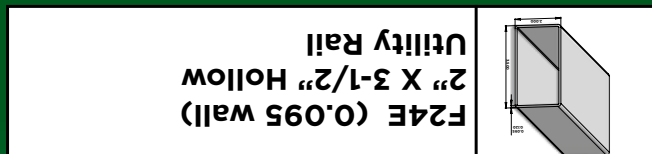
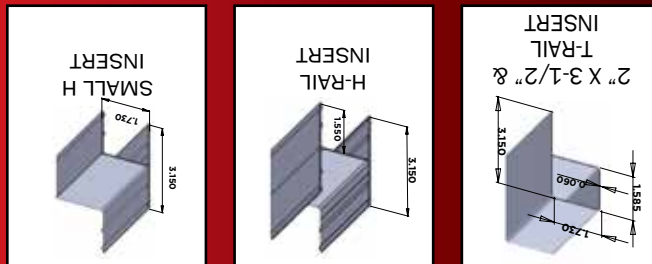
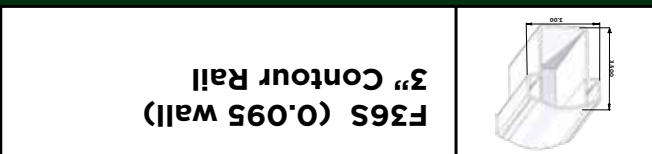

Contour

Deck Over

2" X 3-1/2"

T-Rail



Not all Vinyl Is Created Equal!

Homeland® manufactures the toughest PVC profiles with the most advanced UV protection under the sun, our ACCU-Shield® formulation.

ACCU-Shield is our protective outer layer engineered to significantly reduce oxidation and the damaging effects of the sun's ultraviolet rays. Even in harsh climates, ACCU-Shield protects the color and sheen of our products for a longer period of time. Simply put, there is no better protection under the sun than ACCU-Shield.

Uncompromising quality. Innovative engineering. Enduring craftsmanship.

These qualities are what make Homeland® profiles exceptional. With any Homeland profile you choose, you can be confident your choice will create a distinctive design signature, and will provide you with many years of low-maintenance, worry-free enjoyment. With decades of experience in vinyl and a rigorous quality control program, you can be assured that Homeland Vinyl Products is committed to providing the very best vinyl products the industry has to offer. With vinyl products from Homeland, you get the quality you expect, and options you could only imagine.

For more information, please contact:



Homeland Vinyl Products
Toll Free: 800-999-6813

Waymark® is a registered trademark of Waymark Products LLC.
Summit® is a registered trademark of Waymark Products LLC.
Homeland® is a registered trademark of Homeland Vinyl Products, Inc.
Gorilla™ is a trademark of Homeland Vinyl Products, Inc.
Gorilla® is a registered trademark of Homeland Vinyl Products, Inc.

2023-052
M1152-rev C

SUMMIT®
RAILING SYSTEMS



Beautiful, Durable & Worry Free Railing Systems!

HOMELAND VINYL PRODUCTS, INC.
Toll Free: 800-999-6813
HomelandVinyl.com

WAYMARK FENCE AND RAIL ACCESSORIES
Toll Free: 877-652-6118
WaymarkProducts.com

T-Rail

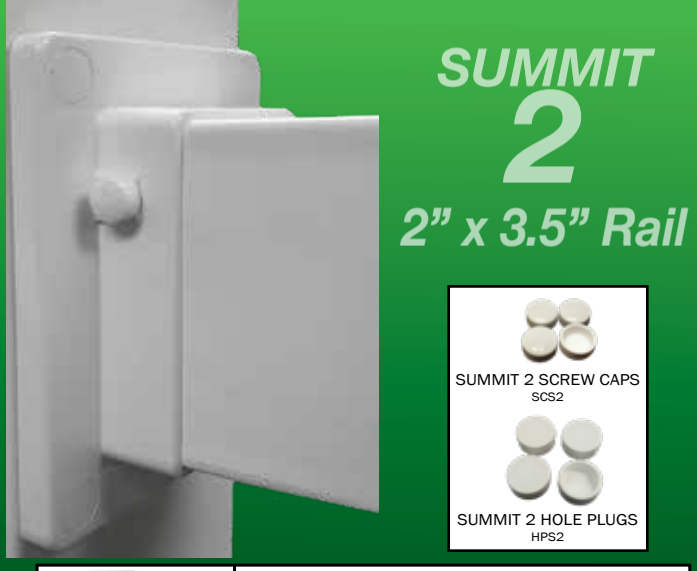

SUMMIT 2
2" x 3.5" Rail



SUMMIT 2
T-Rail

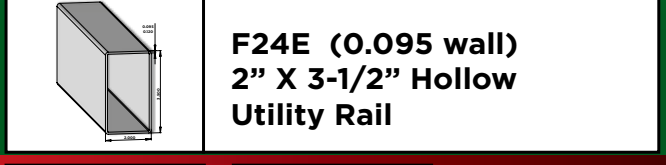

F24E (0.095 wall)
2" X 3-1/2" Hollow Utility Rail

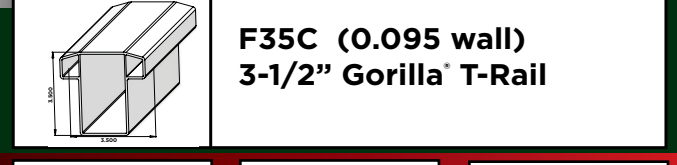

F35C (0.095 wall)
3-1/2" Gorilla® T-Rail



2" X 3-1/2"
SUMMIT 2® BRACKET
BL235S2



2" X 3-1/2"
SUMMIT 2® STAIR BRACKET
- BS235S2



22 1/2 DEGREE
SUMMIT® ADAPTER



T-RAIL SUMMIT 2®
BRACKET
BLTRLS2



T-RAIL SUMMIT 2®
STAIR BRACKET
BS235S2



22 1/2 DEGREE
SUMMIT® ADAPTER

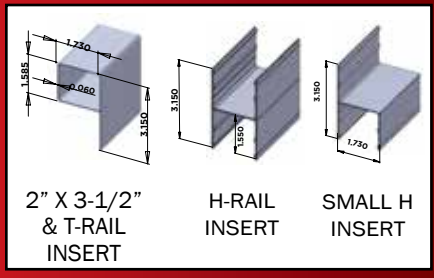

2" X 3-1/2"
& T-RAIL INSERT

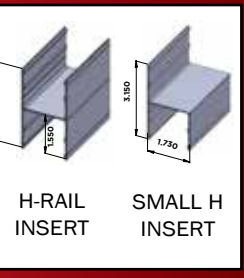

H-RAIL INSERT

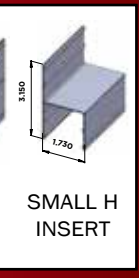

SMALL H INSERT



45 DEGREE
SUMMIT® ADAPTER

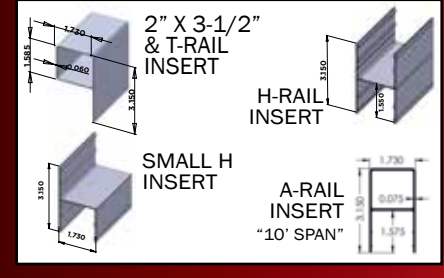

2" X 3-1/2"
& T-RAIL INSERT

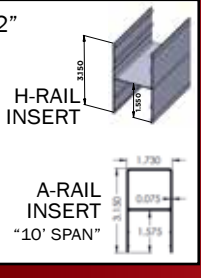

H-RAIL INSERT



SMALL H INSERT

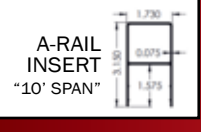

A-RAIL INSERT
"10' SPAN"



45 DEGREE
SUMMIT® ADAPTER

8" COLUMN
SUMMIT® ADAPTER

T- Rail

2" x 3-1/2"



Gorilla Grab Rail®



3" Offset Aluminum Bracket



Straight Aluminum Wall Mount



90 Degree Inside/Outside Corner



12" x 18" x 12" Handicap Loop



180 Degree Post Return
*Not available in black



Inside Corner Mounting Bracket



5 Degree Handicap Elbow



32 Degree Handicap Elbow



34 Degree Handicap Elbow



36 Degree Handicap Elbow



8" Handrail with Aluminum Insert

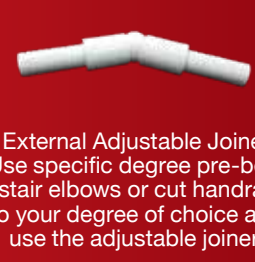

External Adjustable Joiner
Use specific degree pre-bent stair elbows or cut handrail to your degree of choice and use the adjustable joiner.



3" Offset 90 Degree Aluminum Post Return



6" Aluminum Joiner Kit with Screws



Beauty Ring



Colors may not be exactly as shown. Please call for color samples if needed.

CAPS & SOLAR



Pyramid Cap
4" or 5" Options available.



New England Cap
4" or 5" Options available.



Classic Cap
4" or 5" Options available.



Gothic Cap
4" or 5" Options available.



Solar Post Caps
4" or 5" Options available.
Available additions are Frosted Glass or Metal Plated Toppers

Gorilla Wrap®

4 PIECE GORILLA WRAP

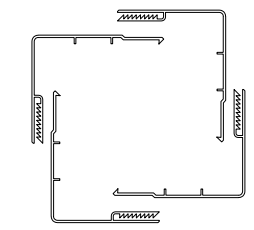

4" Wrap fits from 3-1/4" square to 4-3/8" square posts.

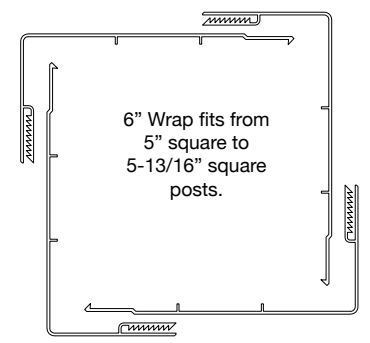

6" Wrap fits from 5" square to 5-13/16" square posts.



8 PIECE GORILLA WRAP

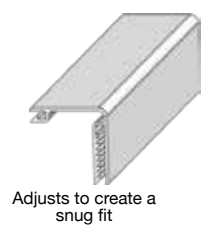
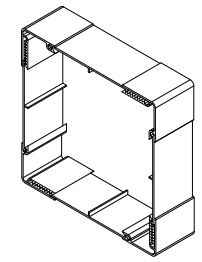
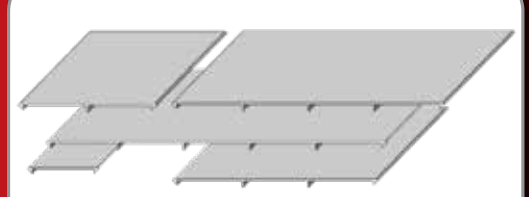

Adjusts to create a snug fit

- Designed for many wrap configurations, rectangular & square up to 12 1/4" wide.
- Interchangeable components allow for customized color mixing of corners and sides.



Gorilla™ Grab Rail - Secondary Handrail



Gorilla® Wrap System